

# G3VM-353H

MOS FET Relays

## Analog-switching MOS FET Relays with SPST-NC Contact.



- Models in 350-V load voltage series with SPST-NC contacts and SOP 6-pin package.

RoHS compliant

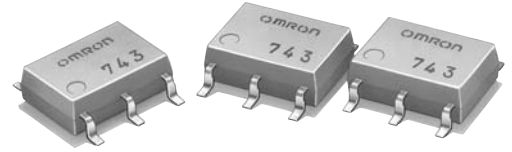

Note: The actual product is marked differently from the image shown here.

### Application Examples

- Semiconductor test equipment
- Test & Measurement equipment
- Communication equipment
- Data loggers

### Terminal Arrangement/Internal Connections

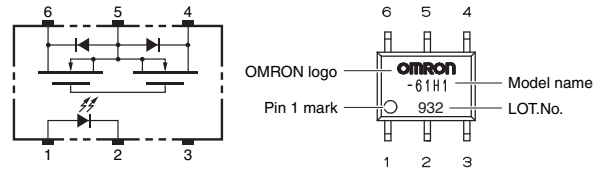

Note: The actual product is marked differently from the image shown here.

### List of Models

| Package type | Contact form | Terminals                  | Load voltage (peak value) * | Model          | Minimum package quantity |                          |
|--------------|--------------|----------------------------|-----------------------------|----------------|--------------------------|--------------------------|
|              |              |                            |                             |                | Number per tube          | Number per tape and reel |
| SOP6         | 1b (SPST-NC) | Surface-mounting Terminals | 350 V                       | G3VM-353H      | 75                       | -                        |
|              |              |                            |                             | G3VM-353H (TR) | -                        | 2,500                    |

\* The AC peak and DC value are given for the load voltage.

### Absolute Maximum Ratings (Ta = 25°C)

| Item  |                                     | Symbol           | Rating      | Unit             | Measurement conditions                             |
|---|-------------------------------------|------------------|-------------|------------------|--|
| Input   | LED forward current                 | IF               | 50          | mA               |  |
|   | Repetitive peak LED forward current | IFP              | 1           | A                | 100 μs pulses, 100 pps                             |
|   | LED forward current reduction rate  | ΔIF/°C           | -0.5        | mA/°C            | Ta ≥ 25°C  |
|   | LED reverse voltage                 | VR               | 5           | V                |  |
| Connection temperature                        |                                     | TJ               | 125         | °C               |  |
| Load voltage (AC peak/DC)                     |                                     | V <sub>OFF</sub> | 350         | V                |  |
| Output  | Continuous load current             | Io               | 120         | mA               | Connection A: AC peak/DC<br>Connection B and C: DC |
|   |                                     |                  | 120         |                  |  |
|   |                                     |                  | 240         |                  |  |
|   | ON current reduction rate           | ΔIo/°C           | -1.2        | mA/°C            | Ta ≥ 25°C  |
|   |                                     |                  | -2.4        |                  |  |
| Connection temperature                        |                                     | TJ               | 125         | °C               |  |
| Pulse ON current                              |                                     | I <sub>op</sub>  | 0.36        | A                | t = 100 ms, Duty = 1/10                            |
| Dielectric strength between I/O (See note 1.) |                                     | V <sub>I-O</sub> | 1500        | V <sub>rms</sub> | AC for 1 min                                       |
| Ambient operating temperature                 |                                     | Ta               | -40 to +85  | °C               | With no icing or condensation                      |
| Ambient storage temperature                   |                                     | T <sub>stg</sub> | -55 to +125 | °C               | With no icing or condensation                      |
| Soldering temperature                         |                                     | -                | 260         | °C               | 10 s   |

Note: 1. The dielectric strength between the input and output was checked by applying voltage between all pins as a group on the LED side and all pins as a group on the light-receiving side.

#### Connection Diagram

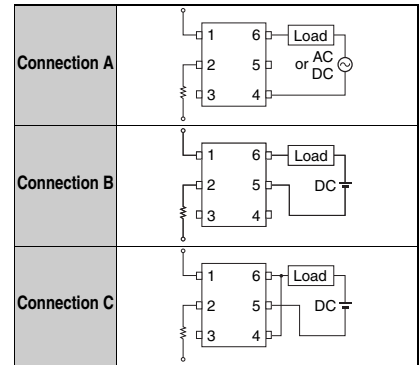

### Electrical Characteristics (Ta = 25°C)

| Item  |                                   | Symbol            | Minimum | Typical         | Maximum | Unit | Measurement conditions  |
|---|-----------------------------------|-------------------|---------|-----------------|---------|------|---|
| Input                                       | LED forward voltage               | V <sub>F</sub>    | 1.0     | 1.15            | 1.3     | V    | I <sub>F</sub> = 10 mA  |
|   | Reverse current                   | I <sub>R</sub>    | -       | -               | 10      | μA   | V <sub>R</sub> = 5 V  |
|   | Capacity between terminals        | C <sub>T</sub>    | -       | 30              | -       | pF   | V = 0, f = 1 MHz  |
|   | Trigger LED forward current       | I <sub>FC</sub>   | -       | 1.0             | 3.0     | mA   | I <sub>OFF</sub> = 10 μA  |
|   | Turn-OFF LED forward current      | I <sub>FT</sub>   | 0.1     | -               | -       | mA   | I <sub>O</sub> = 120 mA   |
| Output                                      | Maximum resistance with output ON | R <sub>ON</sub>   | -       | 15              | 25      | Ω    | I <sub>O</sub> = 120 mA   |
|   |                                   |                   | -       | 8               | 14      | Ω    | I <sub>O</sub> = 120 mA   |
|   |                                   |                   | -       | 4               | -       | Ω    | I <sub>O</sub> = 240 mA   |
| Current leakage when the relay is open      |                                   | I <sub>LEAK</sub> | -       | -               | 1.0     | μA   | V <sub>OFF</sub> = 350 V, I <sub>F</sub> = 5 mA                                     |
| Capacity between terminals                  |                                   | C <sub>OFF</sub>  | -       | 65              | -       | pF   | V = 0, f = 1 MHz, I <sub>F</sub> = 5 mA   |
| Capacity between I/O terminals              |                                   | C <sub>I-O</sub>  | -       | 0.8             | -       | pF   | f = 1 MHz, V <sub>S</sub> = 0 V   |
| Insulation resistance between I/O terminals |                                   | R <sub>I-O</sub>  | 1000    | 10 <sup>8</sup> | -       | MΩ   | V <sub>I-O</sub> = 500 VDC, RoH ≤ 60 %  |
| Turn-ON time                                |                                   | t <sub>ON</sub>   | -       | -               | 1.0     | ms   | I <sub>F</sub> = 5 mA, R <sub>L</sub> = 200 Ω, V <sub>DD</sub> = 20 V (See note 2.) |
| Turn-OFF time                               |                                   | t <sub>OFF</sub>  | -       | -               | 3.0     | ms   |   |

Note: 2. Turn-ON and Turn-OFF Times

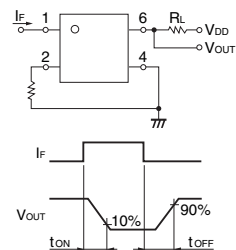

## Recommended Operating Conditions

Use the G3VM under the following conditions so that the Relay will operate properly.

| Item                                 | Symbol   | Minimum | Typical | Maximum | Unit |
|--------------------------------------|----------|---------|---------|---------|------|
| Load voltage (AC peak/DC)            | $V_{DD}$ | -       | -       | 280     | V    |
| Operating LED forward current        | $I_F$    | 5       | -       | 25      | mA   |
| Continuous load current (AC peak/DC) | $I_O$    | -       | -       | 120     | mA   |
| Ambient operating temperature        | $T_a$    | -20     | -       | 65      | °C   |

## Engineering Data

LED forward current vs. Ambient temperature

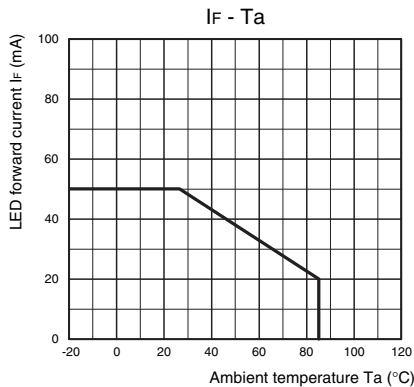

Continuous load current vs. Ambient temperature

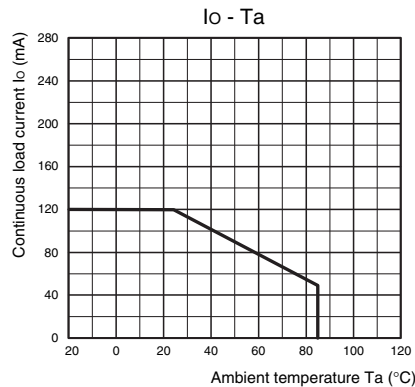

LED forward current vs. LED forward voltage

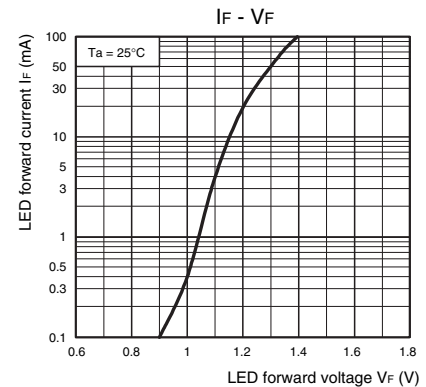

Continuous load current vs. On-state voltage

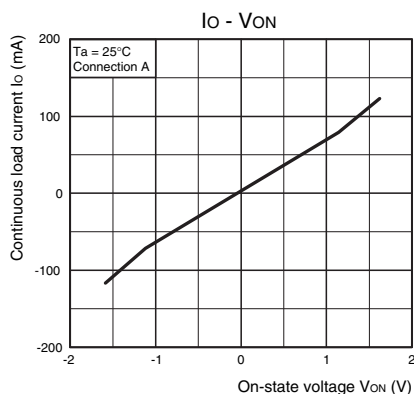

On-state resistance vs. Ambient temperature

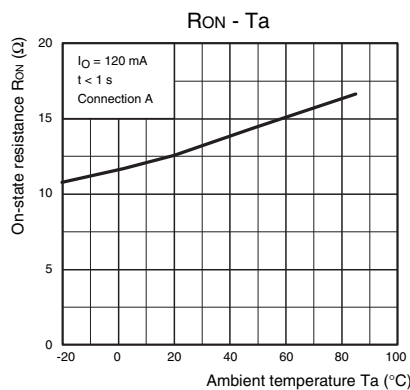

Trigger LED forward current vs. Ambient temperature

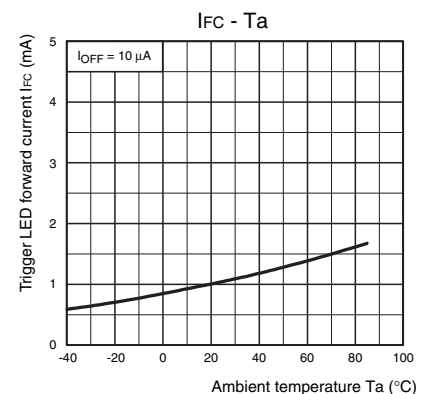

Turn ON, Turn OFF time vs. LED forward current

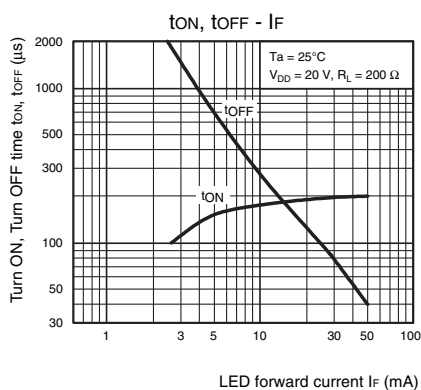

Turn ON, Turn OFF time vs. Ambient temperature

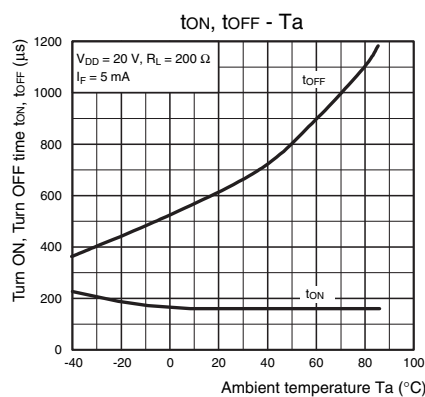

Current leakage vs. Ambient temperature

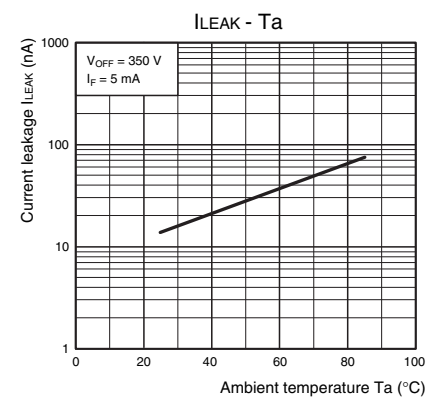

## Safety Precautions

- Refer to "Common Precautions" for all G3VM models.

## ■ Appearance

### SOP (Small Outline Package) SOP6

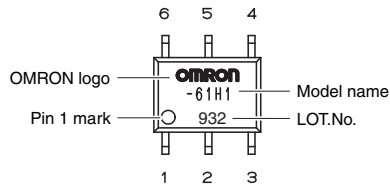

Note: The actual product is marked differently from the image shown here.

## ■ Dimensions

(Unit: mm)

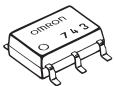

### Surface-mounting Terminals

Weight: 0.13 g

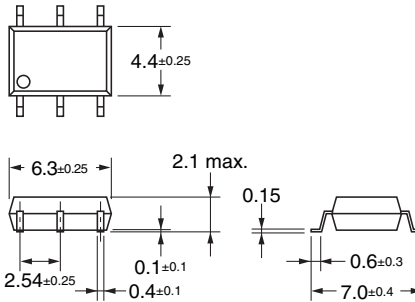

### Actual Mounting Pad Dimensions

(Recommended Value, TOP VIEW)

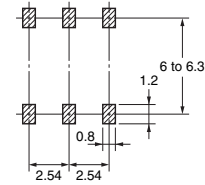

Note: The actual product is marked differently from the image shown here.

- Application examples provided in this document are for reference only. In actual applications, confirm equipment functions and safety before using the product.
- Consult your OMRON representative before using the product under conditions which are not described in the manual or applying the product to nuclear control systems, railroad systems, aviation systems, vehicles, combustion systems, medical equipment, amusement machines, safety equipment, and other systems or equipment that may have a serious influence on lives and property if used improperly. Make sure that the ratings and performance characteristics of the product provide a margin of safety for the system or equipment, and be sure to provide the system or equipment with double safety mechanisms.

Note: Do not use this document to operate the Unit.